

---

# AIR CONDITIONER

## Use & Care Guide

For questions about features, operation/performance, parts, accessories or service call: **1-800-253-1301**

---

Table of Contents ..... 2

---

# TABLE OF CONTENTS

<b>AIR CONDITIONER SAFETY</b> .....	2	Starting Your Air Conditioner—Rotary Control.....	11
<b>INSTALLATION REQUIREMENTS</b> .....	3	Changing Air Direction .....	12
Tools and Parts .....	3	Normal Sounds.....	12
Location Requirements .....	3	<b>AIR CONDITIONER CARE</b> .....	<b>12</b>
Electrical Requirements .....	3	Cleaning the Air Filter .....	12
<b>INSTALLATION INSTRUCTIONS</b> .....	<b>5</b>	Cleaning the Front Panel.....	12
Unpack the Air Conditioner.....	5	Repairing Paint Damage .....	12
Prepare Air Conditioner for Installation.....	5	Annual Maintenance.....	12
Position the Air Conditioner .....	6	<b>TROUBLESHOOTING</b> .....	<b>13</b>
Complete Installation .....	7	<b>ASSISTANCE OR SERVICE</b> .....	<b>14</b>
<b>AIR CONDITIONER USE</b> .....	<b>8</b>	In the U.S.A. ....	14
Starting Your Air Conditioner—Digital Control .....	8	Accessories .....	14

## AIR CONDITIONER SAFETY

### Your safety and the safety of others are very important.

We have provided many important safety messages in this manual and on your appliance. Always read and obey all safety messages.



This is the safety alert symbol.

This symbol alerts you to potential hazards that can kill or hurt you and others.

All safety messages will follow the safety alert symbol and either the word “DANGER” or “WARNING.” These words mean:

**⚠ DANGER**

**You can be killed or seriously injured if you don't immediately follow instructions.**

**⚠ WARNING**

**You can be killed or seriously injured if you don't follow instructions.**

All safety messages will tell you what the potential hazard is, tell you how to reduce the chance of injury, and tell you what can happen if the instructions are not followed.

### IMPORTANT SAFETY INSTRUCTIONS

**WARNING:** To reduce the risk of fire, electrical shock or injury when using your air conditioner, follow these basic precautions:

- Plug into a grounded 3 prong outlet.
- Do not use an extension cord.
- Do not remove ground prong.
- Unplug air conditioner before servicing.
- Do not use an adapter.
- Use two or more people to move and install air conditioner.

**SAVE THESE INSTRUCTIONS**

# INSTALLATION REQUIREMENTS

## Tools and Parts

Gather the required tools and parts before starting installation. Read and follow the instructions provided with any tools listed here.

### Tools needed

- Flat-blade and Phillips screwdrivers
- Tape measure
- Scissors
- Drill and  $\frac{3}{32}$ " or smaller bit

### Parts supplied

Check that all parts are included in parts package.

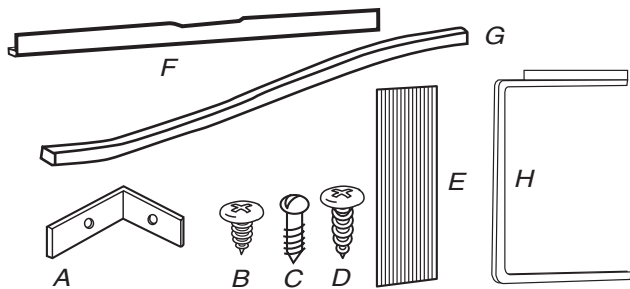

- A. Window-lock bracket
- B. #8 x  $\frac{3}{8}$ " pan-head screws (6)
- C. #8 x  $\frac{3}{4}$ " round-head screws (5)
- D. #10 x  $\frac{3}{8}$ " pan-head screws (3)
- E. Side curtains (2)
- F. Top channel
- G. Foam seal
- H. Side curtain frames (2)

## Location Requirements

**IMPORTANT:** Observe all governing codes and ordinances. Check the location where the air conditioner will be installed. Proper installation is your responsibility. Make sure you have everything necessary for correct installation.

The location should provide:

- Grounded electrical outlet within 4 ft (122 cm) of where the power cord exits the air conditioner.
  - NOTE:** Do not use an extension cord.
- Free movement of air to rooms to be cooled.
- A large enough opening for the air conditioner. Installation parts are supplied for double-hung windows.
- Adequate wall support for weight of air conditioner. Air conditioner weighs 56 lbs (25 kg) to 80 lbs (36 kg).

**NOTE:** Cabinet louvers must not be obstructed. Air must be able to pass freely through the cabinet louvers.

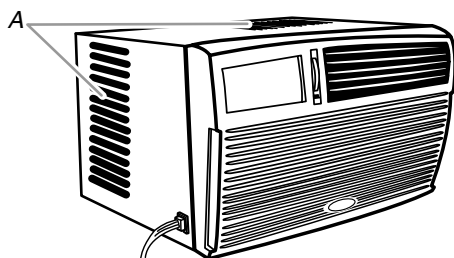

A. Cabinet louvers

## Window installation

Window opening measurements:

- 26" (66 cm) minimum to 38" (95.5 cm) maximum opening width.
- 16" (40.6 cm) minimum opening height.

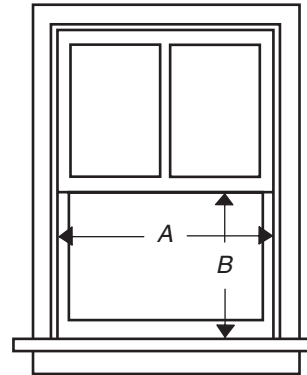

- A. 26" (66 cm) minimum
- B. 16" (40.6 cm) minimum

## Electrical Requirements

### ⚠ WARNING



#### Electrical Shock Hazard

**Plug into a grounded 3 prong outlet.**

**Do not remove ground prong.**

**Do not use an adapter.**

**Do not use an extension cord.**

**Failure to follow these instructions can result in death, fire, or electrical shock.**

The electrical ratings for your air conditioner are listed on the model and serial number label. The model and serial number label is located on the right-hand side of the cabinet.

Specific electrical requirements are listed in the chart below. Follow the requirements for the type of plug on the power supply cord.

Power supply cord	Wiring requirements
	<ul style="list-style-type: none"> <li>■ 115 volt (103.5 min. - 126.5 max.)</li> <li>■ 0-12 amperes</li> <li>■ 15-amp time-delay fuse or circuit breaker</li> <li>■ Use on single outlet circuit only.</li> </ul>

**Recommended ground method**

For your personal safety, this air conditioner must be grounded. This air conditioner is equipped with a power supply cord having a grounded 3 prong plug. To minimize possible shock hazard, the cord must be plugged into a mating, grounded 3 prong outlet, grounded in accordance with all local codes and ordinances. If a mating outlet is not available, it is the customer's responsibility to have a properly grounded 3 prong outlet installed by a qualified electrical installer.

It is the customer's responsibility:

- To contact a qualified electrical installer.
- To assure that the electrical installation is adequate and in conformance with National Electrical Code, ANSI/NFPA 70 - latest edition, and all local codes and ordinances.

Copies of the standards listed may be obtained from:

National Fire Protection Association  
 One Batterymarch Park  
 Quincy, Massachusetts 02269

**Power Supply Cord**

**NOTE:** Your unit's device may differ from the one shown.

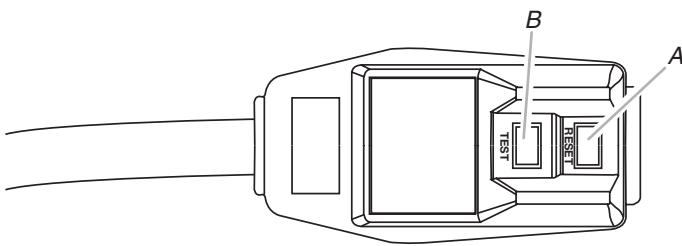

A. Reset button  
 B. Test button

This room air conditioner is equipped with a power supply cord required by UL. This power supply cord contains state-of-the-art electronics that sense leakage current. When the cord is crushed, the electronics detect leakage current and power is disconnected in a fraction of a second.

WARNING



**Electrical Shock Hazard**

**Plug into a grounded 3 prong outlet.**

**Do not remove ground prong.**

**Do not use an adapter.**

**Do not use an extension cord.**

**Failure to follow these instructions can result in death, fire, or electrical shock.**

**To test your power supply cord:**

1. Plug power supply cord into a grounded 3 prong outlet.
2. Press RESET (on some devices, a green light will turn on).
3. Press TEST (listen for click; Reset button trips, and on some devices, a green light will turn off).
4. Press and release RESET (listen for click; Reset button latches, and on some devices, a green light will turn on). The power supply cord is ready for operation.

**NOTES:**

- The Reset button must be pushed in for proper operation.
- The power supply cord must be replaced if it fails to trip when the test button is pressed or fails to reset.
- Do not use the power supply cord as an off/on switch. The power supply cord is designed as a protective device.
- A damaged power supply cord must be replaced with a new power supply cord obtained from the product manufacturer and must not be repaired.
- The power supply cord contains no user serviceable parts. Opening the tamper-resistant case voids all warranty and performance claims.

# INSTALLATION INSTRUCTIONS

## Unpack the Air Conditioner

### **! WARNING**

#### **Excessive Weight Hazard**

**Use two or more people to move and install air conditioner.**

**Failure to do so can result in back or other injury.**

### Remove packaging materials

- Remove and properly dispose of packaging materials. Remove tape and glue residue from surfaces before turning on the air conditioner. Rub a small amount of liquid dish soap over the adhesive with your fingers. Wipe with warm water and dry.
- Do not use sharp instruments, rubbing alcohol, flammable fluids, or abrasive cleaners to remove tape or glue. These products can damage the surface of your air conditioner.
- Handle air conditioner with care.

## Prepare Air Conditioner for Installation

- Handle air conditioner with care.
  - Be sure your air conditioner does not fall out of the opening during installation or removal.
  - The place where the power cord exits the air conditioner should be no more than 4 ft (122 cm) from a grounded outlet.
1. Locate provided bags of screws.
  2. Place the top channel on top of the air conditioner, lining up the holes in top channel with the holes on top of air conditioner.
  3. Using 3 - #10 x  $\frac{3}{8}$ " pan-head screws, attach top channel to air conditioner.

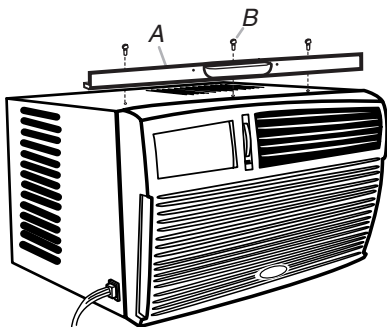

A. Top channel  
B. #10 x  $\frac{3}{8}$ " pan-head screw

## Install side curtains

**NOTE:** Attach curtains to unit before placing unit in window.

1. Insert curtain into curtain frame.

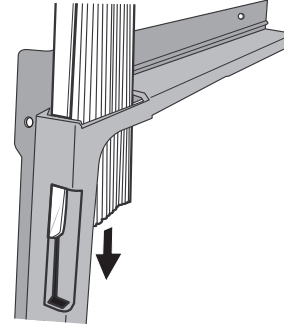

2. Push curtain in all the way.
3. Pull curtain toward open end of curtain frame.

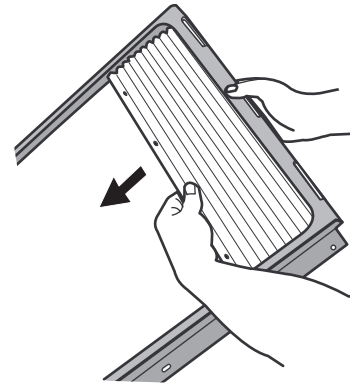

4. Locate provided bag of 6 - #8 x  $\frac{3}{8}$ " pan-head screws.

5. Insert top and then bottom of right-hand curtain frame in top and bottom curtain guides on air conditioner.

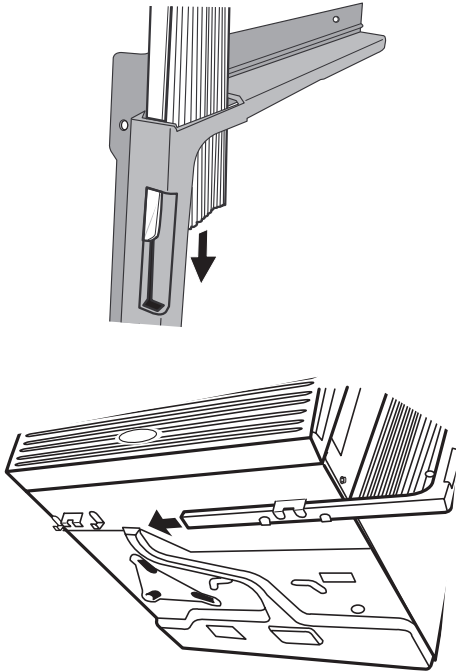

6. Extend right-hand curtain outward so you may insert the first screw through the middle hole of the curtain. Using a #8 x 3/8" pan-head screw, screw curtain to middle hole in air conditioner cabinet.

**NOTE:** This screw is required to correctly attach curtain (top to bottom) to the air conditioner cabinet.

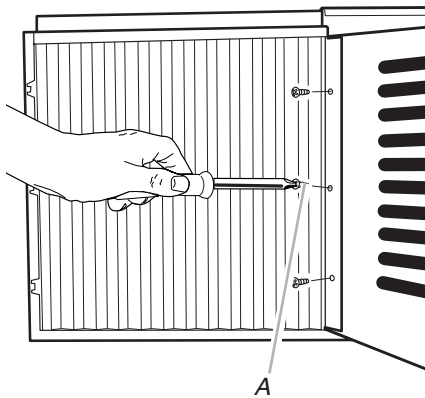

A. #8 x 3/8" pan-head screw

7. While the right-hand curtain is still extended, insert screws into top and bottom slots of curtain. Using #8 x 3/8" pan-head screws, screw curtain to the top and bottom holes in air conditioner cabinet.
8. Slide curtain housing into guides as far as it will go.
9. Repeat above steps for left-hand curtain.

## Position the Air Conditioner

- Handle air conditioner with care.
- Be sure your air conditioner does not fall out of the opening during installation or removal.
- The place where the power cord exits the air conditioner should be no more than 4 ft (122 cm) from a grounded outlet.
- Do not block the louvers on the front panel.
- Do not block the louvers on the outside of the air conditioner.

## ⚠ WARNING

### Excessive Weight Hazard

Use two or more people to move and install air conditioner.

Failure to do so can result in back or other injury.

1. Center air conditioner in window. Check that feet on bottom of air conditioner are behind and against back side of windowsill. Lower window sash to hold cabinet in place.

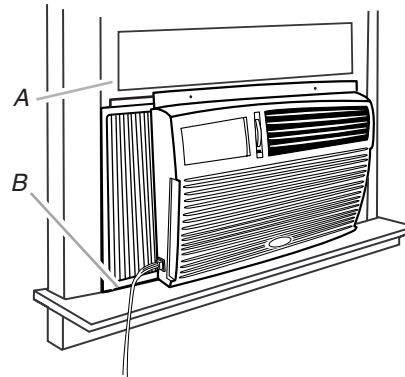

A. Window sash

B. Feet on bottom of air conditioner behind back side of windowsill

2. Pull left-hand curtain frame out until it fits into the window channel. Repeat with right-hand curtain frame.

## Attach side curtains to window

1. Insert one of the #8 x 3/4" round-head screws through left-hand curtain frame and into the window channel to fasten the curtain frame to the window.
2. Repeat for right-hand curtain frame.

**Front view**

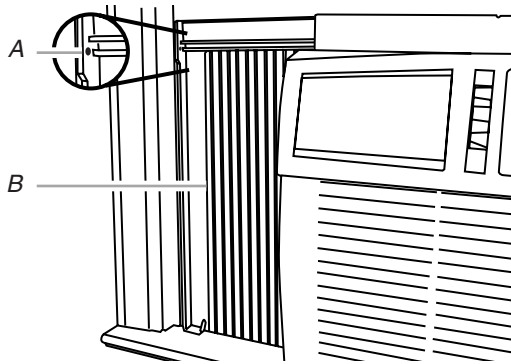

A. Hole for #8 x 3/4" round-head screw  
B. Side curtain

**Top view**

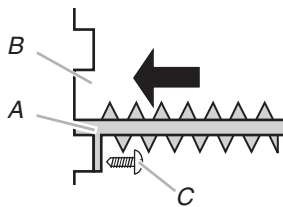

A. Side curtain against window channel  
B. Window channel  
C. #8 x 3/4" round-head screw

3. Insert foam seal behind the top of the lower window sash and against the glass of the upper window.

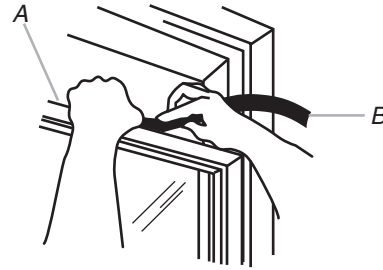

A. Lower window sash  
B. Foam seal

4. Place window-lock bracket on top of lower window and against upper window sash.
5. Use a 3/32" drill bit to drill a starter hole through the hole in the bracket into the window sash.
6. Attach window-lock bracket to window sash with #8 x 3/4" round-head screw to secure window in place.

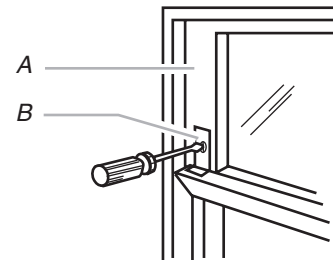

A. Upper window sash  
B. Window-lock bracket

**Complete Installation**

1. Use a 3/32" drill bit to drill starter holes through the holes in the top channel into the window sash.
2. Attach top channel to the window with 2 - #8 x 3/4" round-head screws.

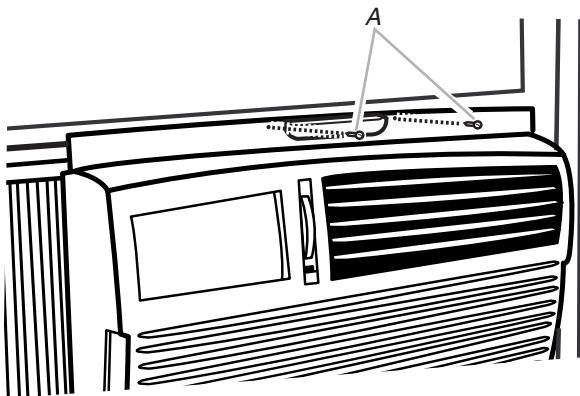

A. #8 x 3/4" round-head screws

**! WARNING**



**Electrical Shock Hazard**

**Plug into a grounded 3 prong outlet.**

**Do not remove ground prong.**

**Do not use an adapter.**

**Do not use an extension cord.**

**Failure to follow these instructions can result in death, fire, or electrical shock.**

7. Plug into a grounded 3 prong outlet.
8. Press RESET on power supply cord.

# AIR CONDITIONER USE

Operating your air conditioner properly helps you to obtain the best possible results.

This section explains proper air conditioner operation.

## IMPORTANT:

- If you turn off the air conditioner, wait at least 3 minutes before turning it back on. This prevents the air conditioner from blowing a fuse or tripping a circuit breaker.
- Do not try to operate your air conditioner in the cooling mode when outside temperature is below 65°F (18°C). The inside evaporator coil will freeze up, and the air conditioner will not operate properly.

**NOTE:** In the event of a power failure, your air conditioner will operate at the previous settings when the power is restored.

## Starting Your Air Conditioner— Digital Control

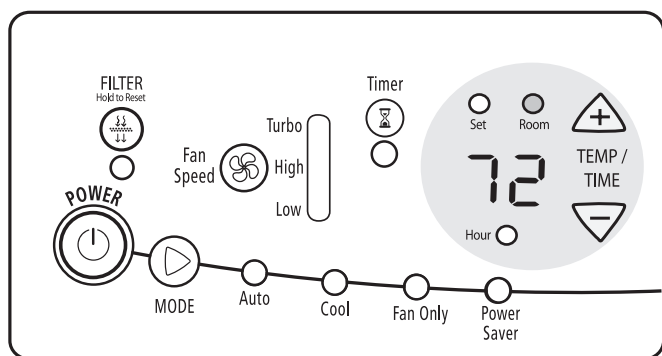

## NOTES:

- When the air conditioner is off, the Room indicator light is lit and the display shows the current room temperature. If the room temperature is below 55°F (13°C), the display will show 55°F (13°C). If the room temperature is above 99°F (37°C), the display will show 99°F (37°C).
- When the Set indicator light is lit, the display shows the temperature control setting. See “Temperature.”
- When the Hour indicator light is lit, the display shows the time remaining on the Timer setting. See “Timer Delay.”

1. Remove clear protective film from control panel and front panel badge.
2. Press POWER to turn on air conditioner.



**NOTE:** When air conditioner is turned on for the first time after it is plugged in, it will display the default settings: Cool mode, Turbo fan speed, 72°F (22°C) for 3 seconds. When it is turned on at all other times, it will display the previous settings for 3 seconds, and then display the room temperature.

3. Select mode. See “Mode.”
4. Select fan speed. See “Fan Speed.”
5. Set temperature. See “Temperature.”

## Mode

1. Press MODE until you see the indicator light come on for the setting you desire.
2. Choose Auto, Cool, Fan Only or Power Saver.
  - Auto—Cools room while it automatically controls fan speed. You cannot change fan speed, but you can adjust temperature by pressing the plus or minus button.
  - Cool—Cools room. You can select fan speed by pressing FAN SPEED. You can then adjust temperature by pressing the plus or minus button.
  - Fan Only—Only the fan runs. You can select the fan speed by pressing FAN SPEED, but you cannot adjust the Temperature control setting. Display shows the current room temperature.
  - Power Saver—You can select the fan speed by pressing FAN SPEED. Fan runs only when cooling is needed. Fan stops running when the room temperature matches the Temperature control setting.

Because the fan does not circulate the room air continuously, less energy is used, but the room air is not circulated as often. Use Power Saver when you are asleep or away from home.

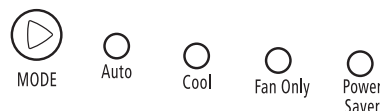

## Fan Speed

**NOTE:** The Fan Speed button will operate only when Cool, Fan Only or Power Saver mode has been selected.

1. Press FAN SPEED until you see the indicator light come on for the setting you desire.
2. Choose Turbo, High or Low.

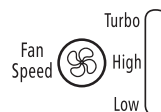

## Filter Reset

1. When FILTER indicator light is lit, remove, clean and replace air filter. See “Cleaning the Air Filter.”
2. Press and hold FILTER for 3 seconds after replacing the air filter.



**NOTE:** After 360 hours of fan run time, the Filter indicator light will turn on. It will remain on for 180 hours or until you press FILTER. After 180 hours, it will flash.



---

## Temperature

---

- Press the plus button to raise the temperature. Room indicator light will turn off and Set indicator light will turn on. Display shows the Temperature control setting. Each time you press or hold the plus button, the temperature will go up 1° until it reaches 86°F (30°C).

**NOTE:** After 3 seconds, Set indicator light will turn off and Room indicator light will turn on. Display will show the current room temperature.

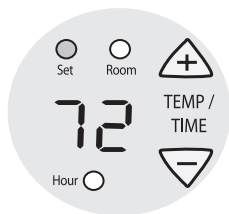

- Press the minus button to lower the temperature. Room indicator light will turn off and Set indicator light will turn on. Display shows the Temperature control setting. Each time you press or hold the minus button, the temperature will go down 1° until it reaches 64°F (18°C).

**NOTE:** After 3 seconds, Set indicator light will turn off and Room indicator light will turn on. Display will show the current room temperature.

### To change the temperature display from °F to °C:

1. Turn off the air conditioner.
2. While the air conditioner is off, press and hold down the MODE and FAN SPEED buttons while pressing POWER to turn on the air conditioner.

**NOTE:** Follow these same steps to change the temperature display from °C to °F.

---

## Timer delay

---

### To set the Timer for a 1- to 24-hour delay until the air conditioner turns off (the air conditioner must be On):

1. Press TIMER. Timer indicator light will flash. Hour indicator light will turn on and display will show remaining hours before air conditioner will turn off.



2. Press the plus or minus button to adjust the delay time (1 to 24 hours).
3. Press TIMER again or wait 10 seconds. Timer indicator light will remain on. Hour indicator light will turn off and Room indicator light will turn on. Display will show the current room temperature.

### To set the Timer to turn on the air conditioner, keeping previous settings:

1. Turn off air conditioner.
2. Press TIMER. Timer indicator light will flash. Hour indicator light will turn on and display will show remaining hours before air conditioner will turn on.
3. Press the plus or minus button to change delay time (1 to 24 hours).
4. Press TIMER again or wait 10 seconds. Timer indicator light will remain on. Hour indicator light will turn off and Room indicator light will turn on. Display will show current room temperature.

### To set the Timer to turn on the air conditioner, changing the previous settings:

1. Turn on air conditioner.
2. Adjust Mode to Auto, Cool, Fan Only, or Power Saver.  
**NOTE:** For Auto mode, go to Step 4.
3. For Cool, Fan Only or Power Saver mode, adjust FAN SPEED to Turbo, High or Low.
4. Adjust temperature between 64°F (18°C) and 86°F (30°C).
5. Wait 3 seconds before turning off air conditioner.
6. Press TIMER. Timer indicator light will flash. Hour indicator light will turn on and display will show remaining hours before air conditioner will turn on.
7. Press the plus or minus button to change delay time (1 to 24 hours).
8. Press TIMER again or wait 10 seconds. Timer indicator light will remain on. Hour indicator light will turn off and Room indicator light will turn on. Display will show current room temperature.

### To clear Timer delay program:

**NOTE:** Air conditioner can be either on or off.

Press and hold TIMER for 3 seconds. Timer indicator light will shut off.

### To see or change the remaining time (in hours):

1. Press TIMER once after it has been programmed. Hour indicator light will turn on and display will show remaining time.
2. While the display is showing the remaining time, you can press the plus or minus button to increase or decrease the time.
3. After 10 seconds, Hour indicator light will turn off and Room indicator light will turn on. Display will show the current room temperature.

## To operate air conditioner with remote control

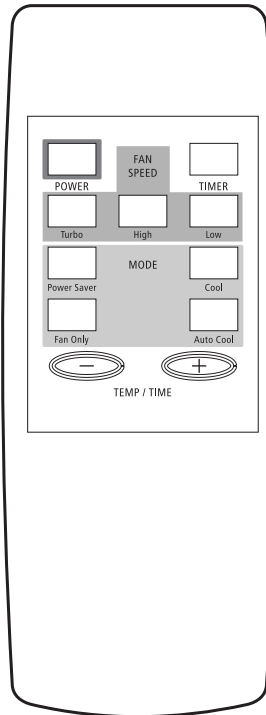

**NOTE:** Two AA batteries (not included) power the remote control. Replace batteries after 6 months of use, or when the remote control starts to lose power.

### To turn the air conditioner on or off:

Press POWER.

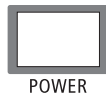

### To select the mode:

Press AUTO COOL, COOL, FAN ONLY, or POWER SAVER.

- Auto Cool—fan speed is adjusted automatically.
- Cool, Fan Only or Power Saver—you can adjust the fan speed.

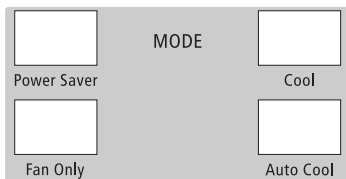

### To select the fan speed (in Cool, Fan Only or Power Saver mode only):

Press TURBO, HIGH or LOW.

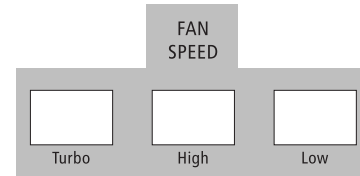

### To raise the temperature:

Press the plus button. Room indicator light on air conditioner will turn off and Set indicator light on air conditioner will turn on. Display on air conditioner shows the Temperature control setting. Each time you press or hold the plus button, the temperature will increase 1° until it reaches 86°F (30°C).

**NOTE:** After 3 seconds, Set indicator light on air conditioner will turn off and Room indicator light on air conditioner will turn on. Display on air conditioner will show the current room temperature.



### To lower the temperature:

Press the minus button. Room indicator light on air conditioner will turn off and Set indicator light on air conditioner will turn on. Display on air conditioner shows the Temperature control setting. Each time you press or hold the minus button, the temperature will decrease 1° until it reaches 64°F (18°C).

**NOTE:** After 3 seconds, Set indicator light on air conditioner will turn off and Room indicator light on air conditioner will turn on. Display on air conditioner will show the current room temperature.



### To set the Timer for a 1- to 24-hour delay until the air conditioner turns off (the air conditioner must be On):

1. Press TIMER. Timer indicator light on air conditioner will flash. Hour indicator light will turn on and display will show remaining hours before air conditioner will turn off.



2. Press the plus or minus button to change delay time (1 to 24 hours).
3. Press TIMER again or wait 10 seconds. Timer indicator light on air conditioner will remain on. Hour indicator light on air conditioner will turn off and Room indicator light on air conditioner will turn on. Display on air conditioner will show the current room temperature.

### To set Timer to turn on air conditioner, keeping previous settings:

1. Turn off air conditioner.
2. Press TIMER. Timer indicator light on air conditioner will flash. Hour indicator light will turn on and display will show remaining hours before air conditioner will turn off.
3. Press the plus or minus button to change delay time (1 to 24 hours).
4. Press TIMER again or wait 10 seconds. Timer indicator light on air conditioner will remain on. Hour indicator light will turn off and Room indicator light will turn on. Display will show the current room temperature.

### To set Timer to turn on air conditioner, changing the previous settings:

1. Turn on air conditioner.
2. Adjust Mode to Auto Cool, Cool, Fan Only, or Power Saver.  
**NOTE:** For Auto Cool mode, go to Step 4.
3. For Cool, Fan Only or Power Saver mode, adjust Fan Speed to Turbo, High or Low.
4. Adjust temperature between 64°F (18°C) and 86°F (30°C).
5. Wait 3 seconds before turning off air conditioner.
6. Press TIMER. Timer indicator light on air conditioner will flash. Hour indicator light will turn on and display will show remaining hours before air conditioner will turn on.
7. Press the plus or minus button to change delay time (1 to 24 hours).
8. Press TIMER again or wait 10 seconds. Timer indicator light on air conditioner will remain on. Hour indicator light will turn off and Room indicator light will turn on. Display will show current room temperature.

## Starting Your Air Conditioner— Rotary Control

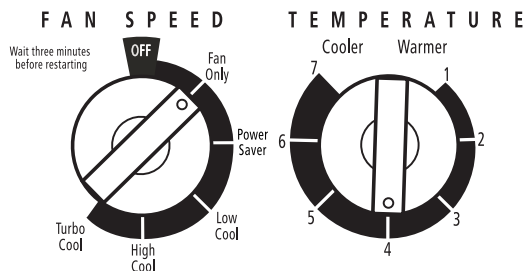

1. Remove clear protective film from front panel badge (on some models).
2. Set exhaust control. See “Exhaust Control (on some models).”
3. Select the fan speed. See “Fan Speed.”
4. Select temperature. See “Temperature.”

### Exhaust Control (on some models)

Push the Exhaust control CLOSED for maximum continuous cooling. Pull the Exhaust control OPEN to allow you to draw stale or smoky air from the room.

- Open—pull to exhaust room air to the outside
- Closed—push to circulate room air

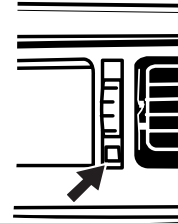

**NOTE:** The Exhaust control will function only when the Fan Speed control is operating.

### Fan Speed

Set FAN SPEED to the desired setting. When the air conditioner is operating at Low Cool, High Cool, or Turbo Cool, the fan circulates air continuously.

- Turbo Cool—for maximum cooling
- High Cool—for normal cooling
- Low Cool—for sleeping comfort
- Fan Only—to move air continuously without cooling

**NOTE:** Fan runs on Turbo speed only.

- Power Saver—fan runs only when cooling is needed. Fan stops circulating air when the room temperature matches the Temperature control setting.

Because the fan does not circulate the room air continuously, less energy is used, but the room air is not circulated as often. Use Power Saver when you are asleep or away from home.

**NOTE:** Fan runs on Low speed only.

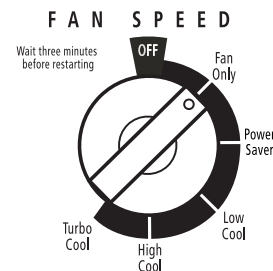

---

## Temperature

---

Turn the TEMPERATURE control to a mid-setting. Adjust the air conditioner's performance by turning the Temperature control clockwise for maximum cooling. For less cooling, turn the TEMPERATURE control counterclockwise. Experiment to find the setting that suits you best.

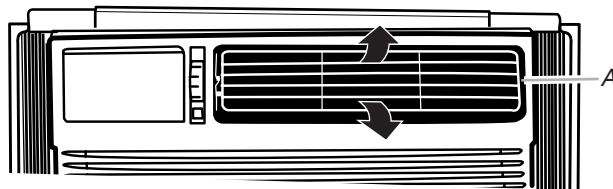
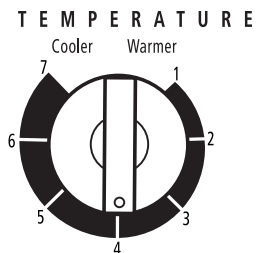

A. Cartridge

---

## Changing Air Direction

Roll the wheel to direct the air right or left. Rotate the whole cartridge to direct air up, down or straight ahead.

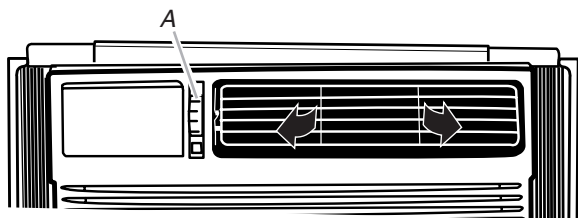

A. Wheel

---

## Normal Sounds

When your air conditioner is operating normally, you may hear sounds such as:

- Droplets of water hitting the condenser, causing a pinging or clicking sound. The water droplets help cool the condenser.
- Air movement from the fan.
- Clicks from the thermostat cycle.
- Vibrations or noise due to poor wall or window construction.
- A high-pitched hum or pulsating noise caused by the modern high-efficiency compressor cycling on and off.

---

# AIR CONDITIONER CARE

Your new air conditioner is designed to give you many years of dependable service. This section tells you how to clean and care for your air conditioner properly. Call your local authorized dealer for an annual checkup. Remember... the cost of this service call is your responsibility.

---

## Cleaning the Air Filter

The air filter is removable for easy cleaning. A clean filter helps remove dust, lint, and other particles from the air and is important for best cooling and operating efficiency. Check the filter every 2 weeks to see whether it needs cleaning.

**NOTE:** Do not operate the air conditioner without the filter in place.

1. Turn off air conditioner.
2. Remove air filter by sliding filter out from either side of unit.

3. Use a vacuum cleaner to clean air filter. If air filter is very dirty, wash it in warm water with a mild detergent. Do not wash air filter in the dishwasher or use any chemical cleaners. Air dry filter completely before replacing to ensure maximum efficiency.
4. Replace air filter by sliding filter back into either side of unit.

---

## Cleaning the Front Panel

1. Unplug air conditioner or disconnect power.
2. Remove the air filter and clean it separately. See "Cleaning the Air Filter."
3. Wipe the front panel with a soft, damp cloth.
4. Air dry front panel completely.
5. Plug in air conditioner or reconnect power.

---

## Repairing Paint Damage

Check once or twice a year for paint damage. This is very important, especially in areas near oceans or where rust is a problem. If needed, touch up with a good grade enamel paint.

**NOTE:** To reduce paint damage during the winter, install a heavy-duty cover over air conditioner cabinet. For information on ordering a heavy-duty cover, see "Accessories."

---

## Annual Maintenance

Your air conditioner needs annual maintenance to help ensure steady, top performance throughout the year. Call your local authorized dealer to schedule an annual checkup. The expense of an annual inspection is your responsibility.

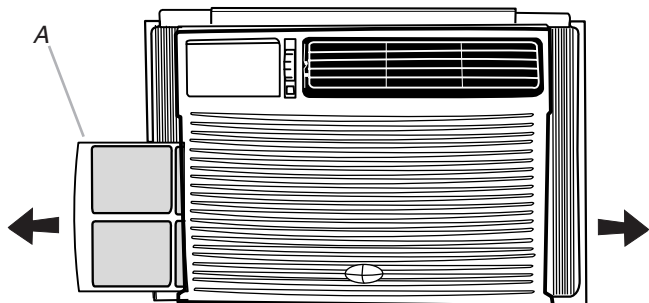

A. Filter may be removed from either side.

---

# TROUBLESHOOTING

You can solve many common air conditioner problems easily, saving you the cost of a service call. Try the suggestions below to see whether you can solve your problem without outside help.

---

## Air conditioner will not operate

- **The power supply cord is unplugged.** Plug into a grounded 3 prong outlet. See “Electrical Requirements.”
- **The power supply cord has tripped (Reset button has popped out; on some devices, a green light will turn off).** Press and release RESET (listen for click; Reset button will latch and remain in; on some devices, a green will turn on) to resume operation.
- **A household fuse has blown, or a circuit breaker has tripped.** Replace the fuse, or reset the circuit breaker. See “Electrical Requirements.”
- **Depending on model, the Power button has not been pressed or the Fan Speed control is turned to Off.** Press POWER button or turn the FAN SPEED control to an active setting.
- **The local power has failed.** Wait for power to be restored.

---

## Air conditioner blows fuses or trips circuit breakers

- **Too many appliances are being used on the same circuit.** Unplug or relocate appliances that share the same circuit.
- **Time-delay fuse or circuit breaker of the wrong capacity is being used.** Replace with a time-delay fuse or circuit breaker of the correct capacity. See “Electrical Requirements.”
- **An extension cord is being used.** Do not use an extension cord with this or any other appliance.
- **You are trying to restart the air conditioner too soon after turning the unit off.** Wait at least 3 minutes after turning the unit off before trying to restart the air conditioner.

---

## Air conditioner power supply cord trips (Reset button pops out)

- **Disturbances in your electrical current can trip (Reset button will pop out; on some devices, a green light will turn off) the power supply cord.** Press and release RESET (listen for click; Reset button will latch and remain in; on some devices, a green light will turn on) to resume operation.
- **An electrical overloading, overheating, pinching or aging can trip (Reset button will pop out; on some devices, a green light will turn off) the power supply cord.** After correcting the problem, press and release RESET (listen for click; Reset button will latch and remain in; on some devices, a green light will turn on) to resume operation.

**NOTE:** A damaged power supply cord must be replaced with a new power supply cord obtained from the product manufacturer and must not be repaired.

---

## Air conditioner seems to run too much

- **The current air conditioner replaced an older model.** The use of more efficient components may cause the air conditioner to run longer than an older model, but the total energy consumption will be less. Newer air conditioners do not emit the “blast” of cold air you may be accustomed to from older units, but this is not an indication of lesser cooling capacity or efficiency. Refer to the efficiency rating (EER) and capacity rating (in BTUs/hr.) marked on the air conditioner.

- **The air conditioner is in a heavily occupied room, or heat-producing appliances are in use in the room.** Use exhaust vent fans while cooking or bathing and try not to use heat-producing appliances during the hottest part of the day. A higher capacity air conditioner may be required, depending on the size of the room being cooled.

---

## Air conditioner cycles on and off too much or does not cool

- **The Mode is set to Power Saver (on some models).** Use Power Saver only when you are away from home or asleep, since the fan does not circulate the room air continuously. Use Low, High or Turbo for your best comfort.
- **The air conditioner is not properly sized for your room.** Check the cooling capabilities of your room air conditioner. Room air conditioners are not designed to cool multiple rooms.
- **The filter is dirty or obstructed by debris.** Clean the filter.
- **The inside evaporator and outside condenser coils are dirty or obstructed by debris.** See “Annual Maintenance.”
- **There is excessive heat or moisture (open container cooking, showers, etc.) in the room.** Use a fan to exhaust heat or moisture from the room. Try not to use heat-producing appliances during the hottest part of the day.
- **The louvers are blocked.** Install the air conditioner in a location where the louvers are free from curtains, blinds, furniture, etc.
- **The outside temperature is below 65°F (18°C).** Do not try to operate your air conditioner in the cooling mode when the outside temperature is below 65°F (18°C).
- **The temperature of the room you are trying to cool is extremely hot.** Allow extra time for the air conditioner to cool off a very hot room.
- **Windows or doors to the outside are open.** Close all windows and doors.
- **The Exhaust control is set to OPEN (on some models).** Push the Exhaust control CLOSED for maximum cooling.
- **Depending on model, the Temp/Time or Temperature control is not at a cool enough setting.** Adjust the TEMP/TIME control to a cooler setting by pressing the minus button to reduce the temperature, or adjust the TEMPERATURE control to a cooler setting by turning the knob clockwise. Set the FAN SPEED control to Turbo or Turbo Cool.

---

## Water drips from cabinet into your house

- **The air conditioner is not properly leveled.** The air conditioner should slope slightly downward toward the outside. Level the air conditioner to provide a downward slope toward the outside to ensure proper drainage. See the Installation Instructions.

**NOTE:** Do not drill a hole in the bottom of the metal base and condensate pan.

---

# ASSISTANCE OR SERVICE

Before calling for assistance or service, please check “Troubleshooting.” It may save you the cost of a service call. If you still need help, follow the instructions below.

When calling, please know the purchase date and the complete model and serial number of your appliance. This information will help us to better respond to your request.

## If you need replacement parts

If you need to order replacement parts, we recommend that you use only factory-authorized replacement parts. These replacement parts will fit right and work right because they are made with the same precision used to build every new appliance.

To locate factory-authorized replacement parts in your area, call us or your nearest designated service center.

---

## In the U.S.A.

Call the Customer eXperience Center toll free: **1-800-253-1301**.

### Our consultants provide assistance with:

- Features and specifications on our full line of appliances.
- Installation information.
- Use and maintenance procedures.
- Accessory and repair parts sales.
- Specialized customer assistance (Spanish speaking, hearing impaired, limited vision, etc.).
- Referrals to local dealers, repair parts distributors, and service companies. Our service technicians are trained to fulfill the product warranty and provide after-warranty service, anywhere in the United States.

To locate the authorized service company in your area, you can also look in your telephone directory Yellow Pages.

### For further assistance

If you need further assistance, you can write with any questions or concerns at:

Customer eXperience Center  
553 Benson Road  
Benton Harbor, MI 49022-2692

Please include a daytime phone number in your correspondence.

### Please record your model's information.

Whenever you call to request service on your appliance, you need to know your complete model number and serial number. You can find this information on the model and serial number label. See “Electrical Requirements” for model and serial number location.

Please record the model and serial number information below. Also, record the purchase date of your appliance and the store's name, address, and telephone number.

**Model Number** \_\_\_\_\_

**Serial Number** \_\_\_\_\_

**Purchase Date** \_\_\_\_\_

**Store Name** \_\_\_\_\_

**Store Address** \_\_\_\_\_

**Store Phone** \_\_\_\_\_

Keep this book and the sales slip together for future reference.

---

## Accessories

You can order the following accessories for your air conditioner from your local authorized dealer or by calling **1-800-253-1301** from anywhere in the U.S.A.

---

### Replacement air filters

A good, clean air filter is important for best cooling with least energy consumption. Your air filter should be cleaned regularly. See “Cleaning the Air Filter” for cleaning instructions. We suggest you replace your air filter once a year.

---

### Heavy-duty cover

If you decide to leave your air conditioner installed during the winter, a heavy-duty cover will help protect your air conditioner and reduce drafts. The outdoor cover protects against cold drafts through the unit's air passages and protects the cabinet from snow, rain, sleet, rust, and dust.

- For a heavy-duty outdoor cover sized to fit your air conditioner, order Part Number 484184.
- For a heavy-duty indoor cover sized to fit your air conditioner, order Part Number 4396497.

---

## Notes

